

REV	DESCRIPTION	DATE
01	INITIAL RELEASE	09/30/11
.	.	.
.	.	.

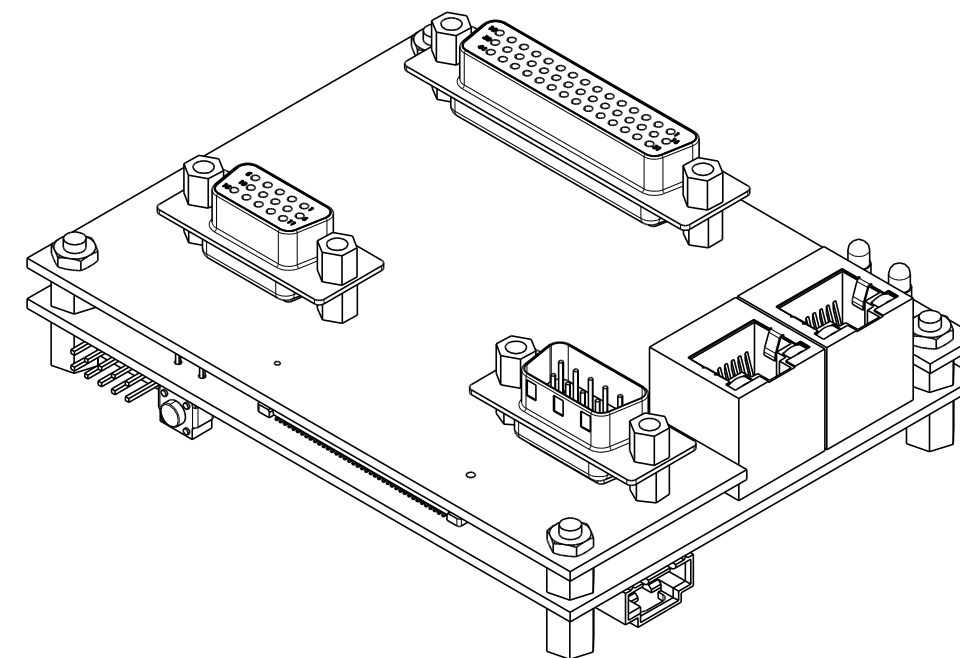

UNLESS OTHERWISE SPECIFIED: DIMENSIONS ARE IN INCHES		GALIL MOTION CONTROL	
TOLERANCES ARE: .XX ± .025 .XXX ± .010		270 TECHNOLOGY WAY ROCKLIN, CA 95765 (916) 626-0101	
MATERIAL:	N/A	TITLE DIMENSIONS	
FINISH:	N/A	PART NUMBER DMC-30010-CARD	REV 01
		SCALE: 1=1	SHEET: 1 OF 1

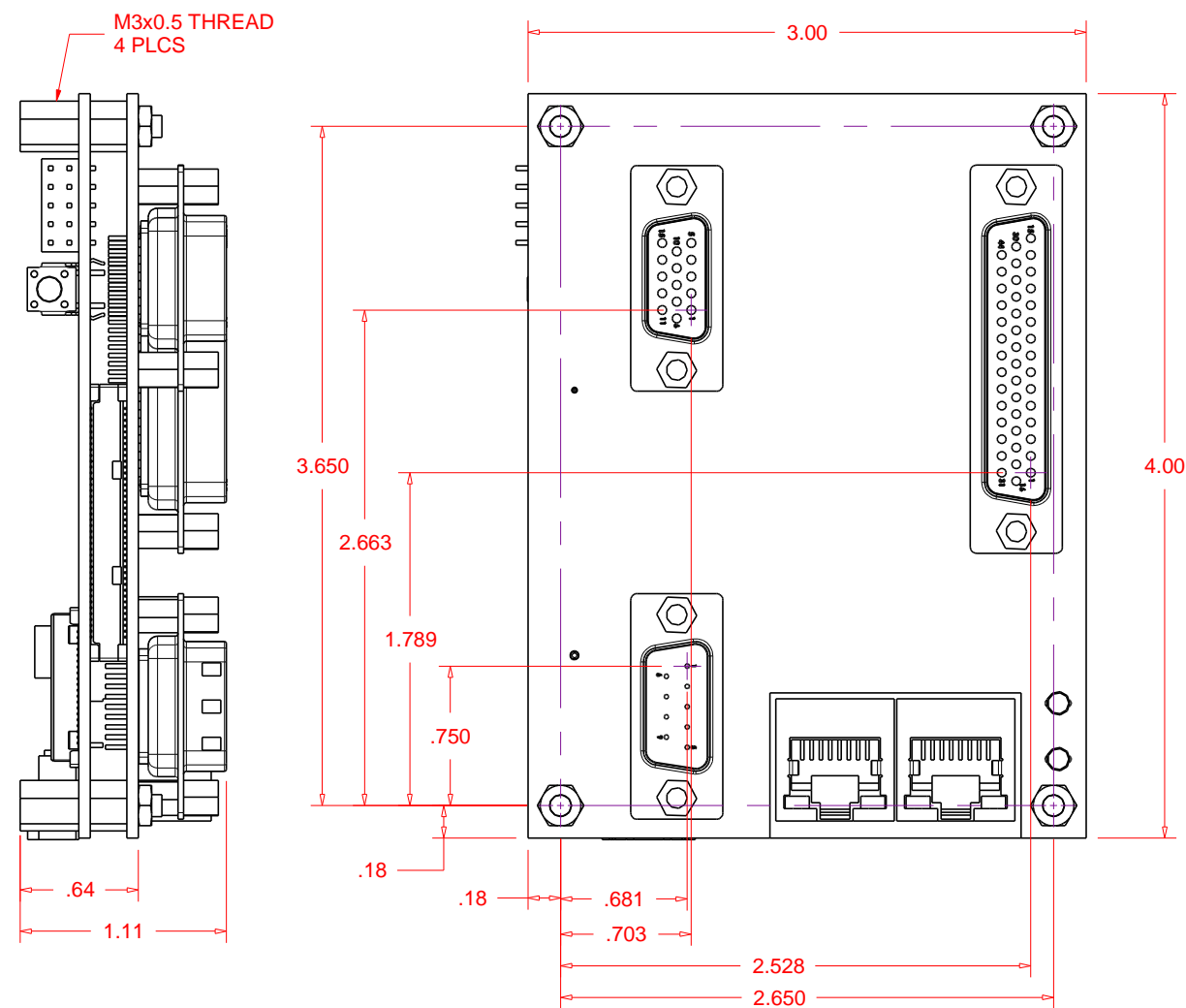